

●



- ✓
- ✓
- ✓
- ✓
- ✓
- ✓
- ✓
- ✓

AC

●

ED

ED

ED

ED

●

E

E

GB

E

E

GB

●

C A

AC

ED

ED

ED

ED

ED

ED

●

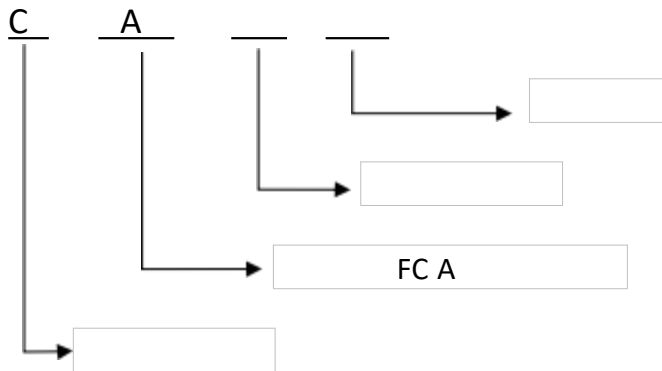



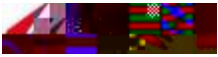

■ 环境温度降额曲线

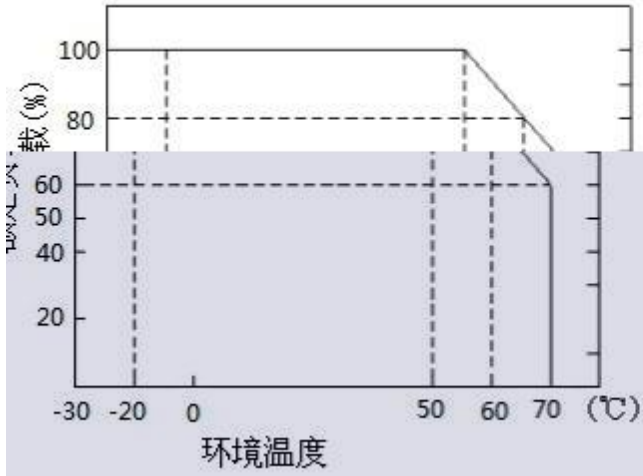

■ 输入电压降额曲线

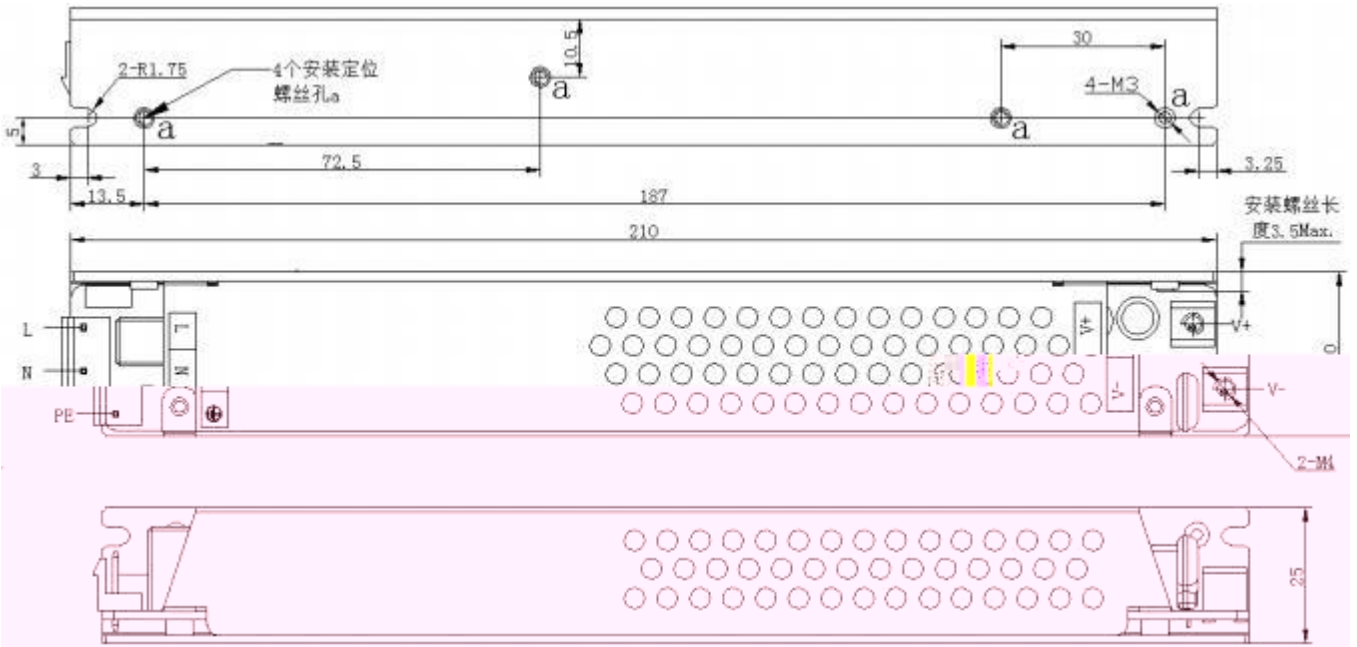
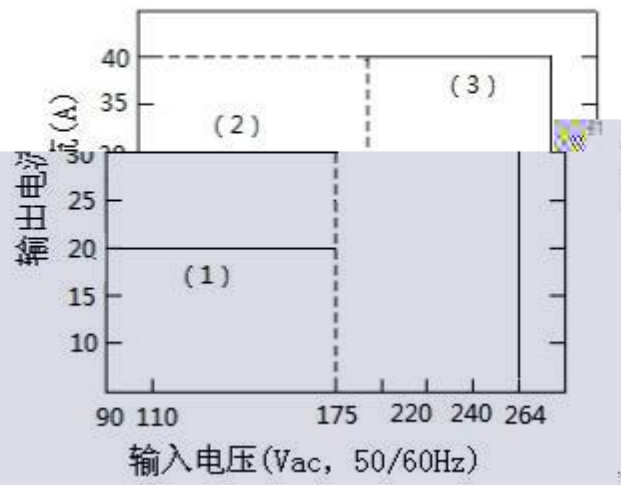

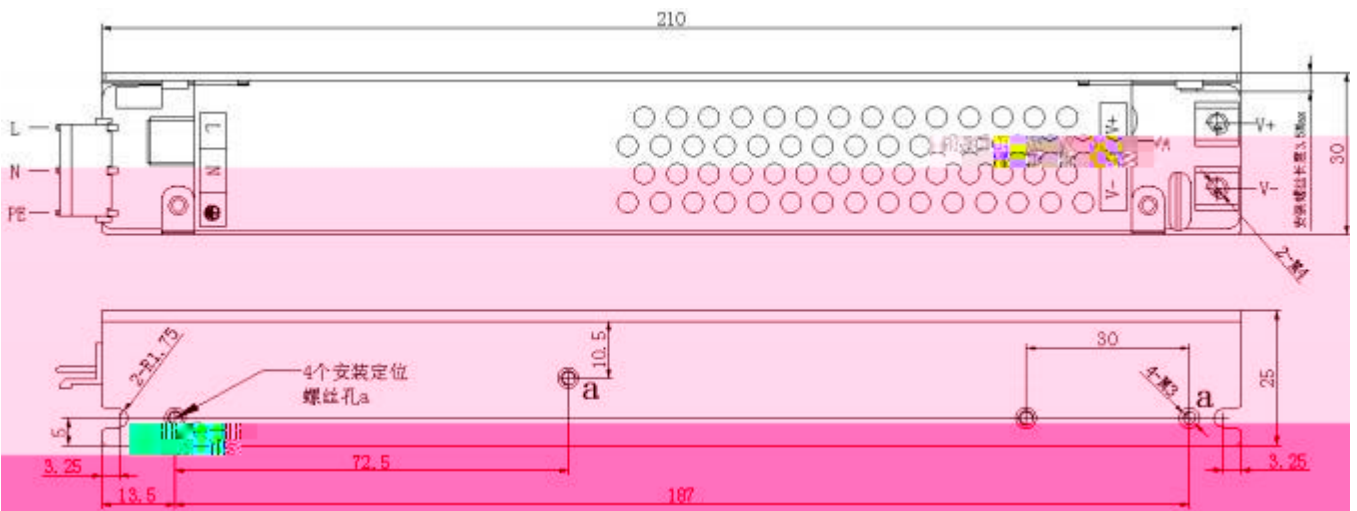
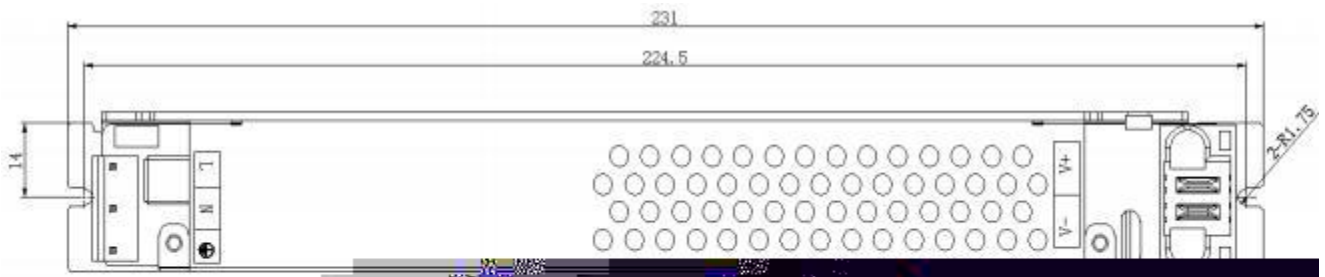
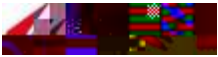

|  |  |
|--|--|
| <p><b>警示</b></p> <ul style="list-style-type: none"><li>• 使用安装螺丝 M3*6mm,</li><li>• 深入外壳螺丝深度 MAX 3mm,</li><li>• 详见右图</li></ul> |  |
|--|--|

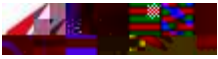

C A

---



A G

