

●



- ✓
- ✓
- ✓ - 0 + 0
- ✓ 0
- ✓ / /
- ✓
- ✓ 00%
- ✓

●

●

●

●

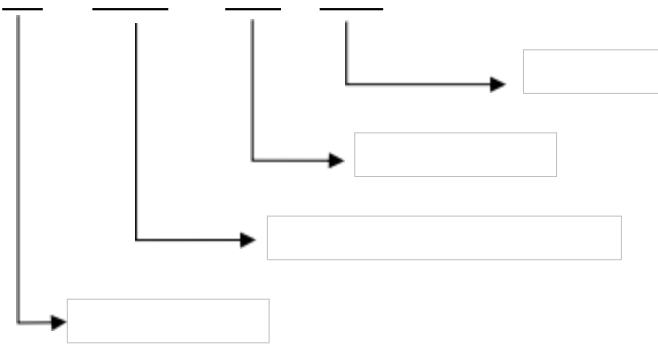



		<input checked="" type="checkbox"/>	<input type="checkbox"/>	
		<input type="checkbox"/>	<input type="checkbox"/>	<input type="checkbox"/>



■ 环境温度降额曲线

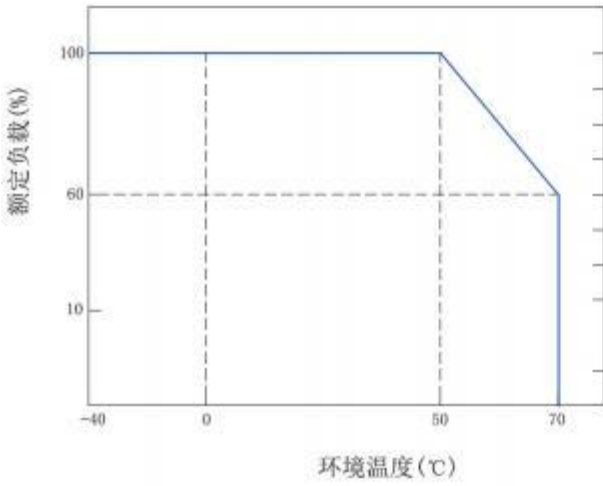

■ 输入电压降额曲线

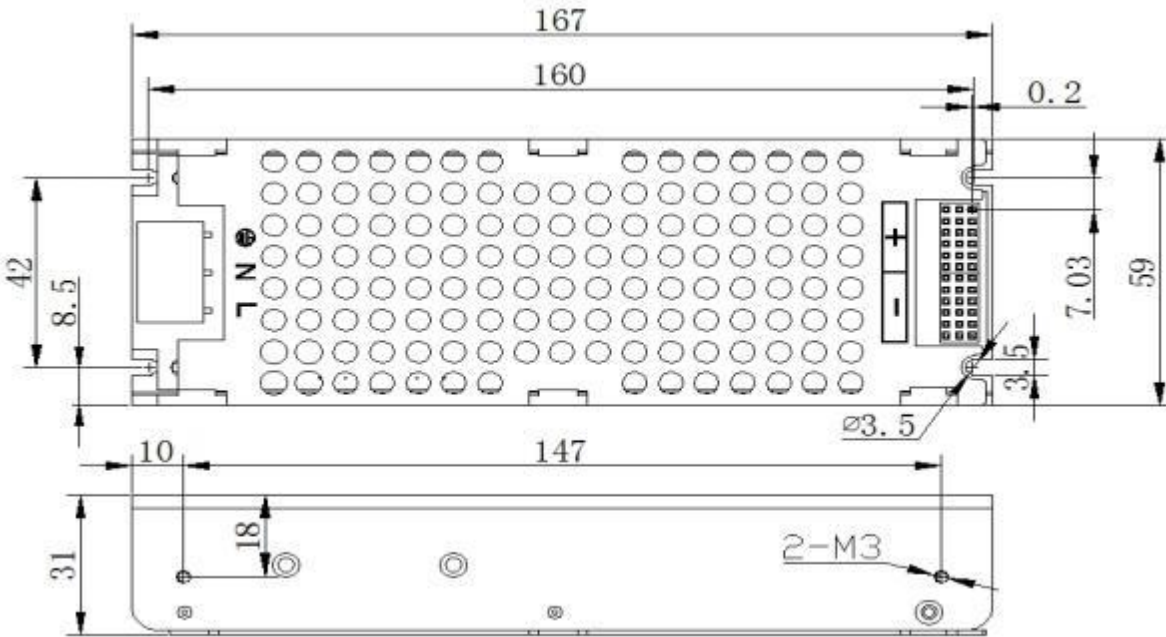
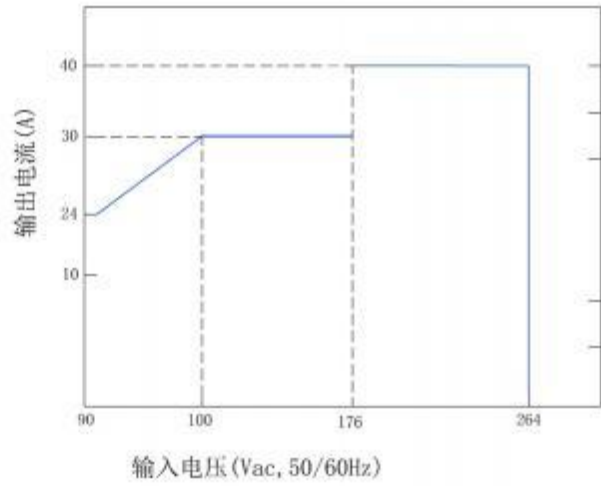

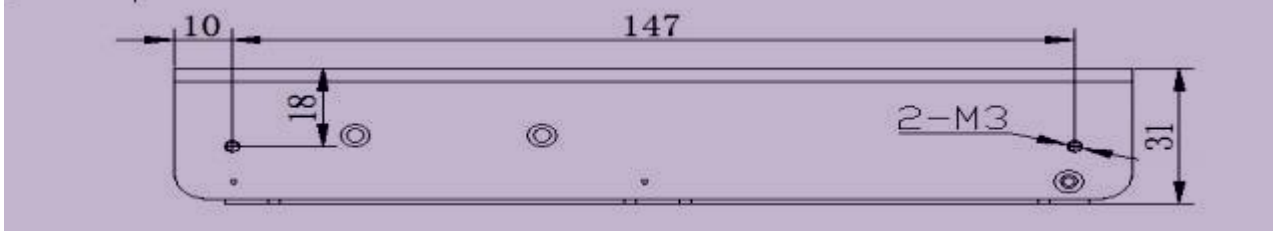
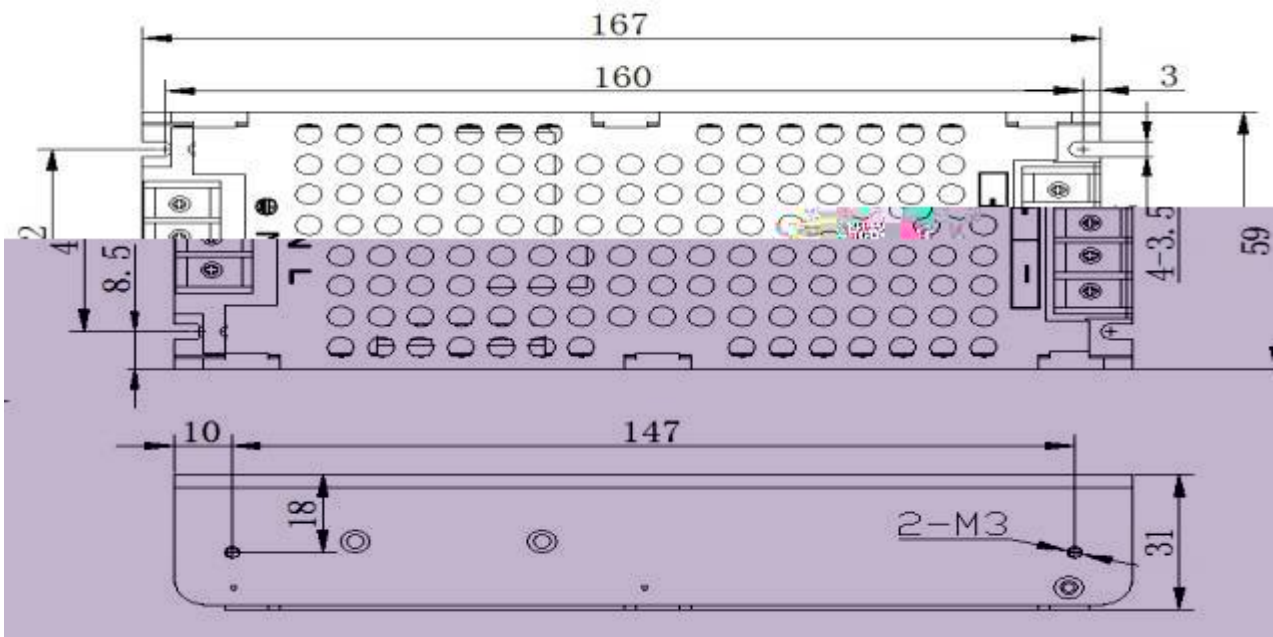
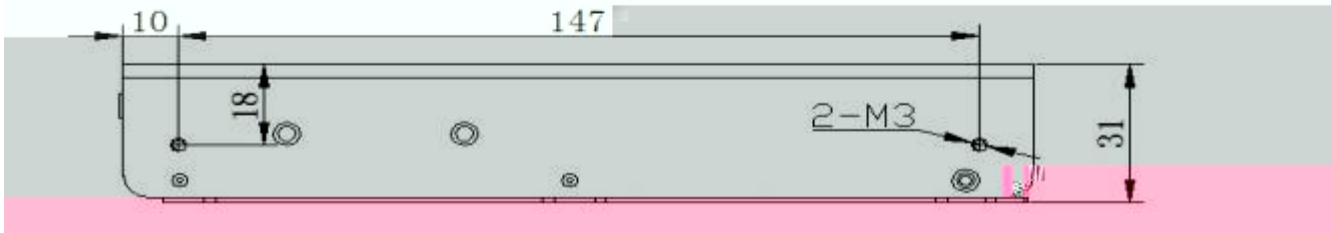
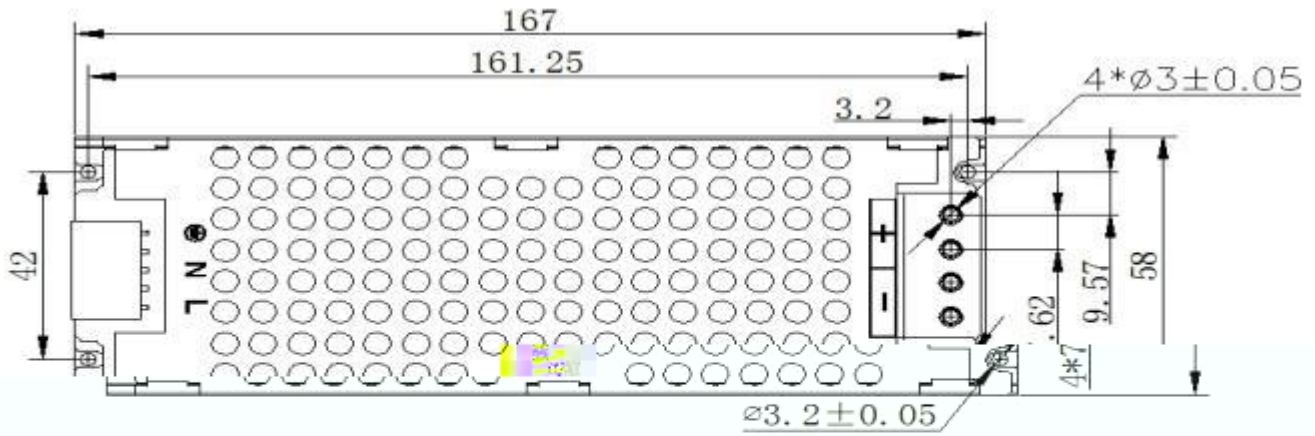

警示

- 使用安装螺丝 M3*6mm.
- 深入外壳螺丝深度 MAX 3mm.
- 详见右图

