

●



- ✓
- ✓
- ✓
- ✓
- ✓
- ✓
- ✓
- ✓

●

●

●

●

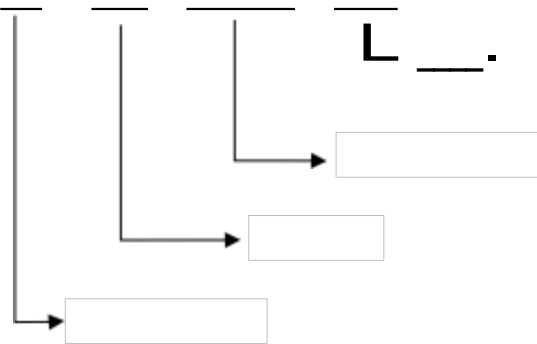



■ 环境温度降额曲线

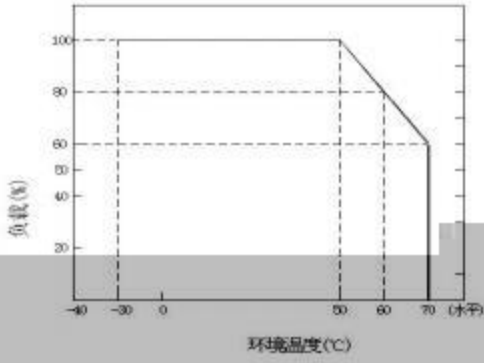

■ 输入电压降额曲线

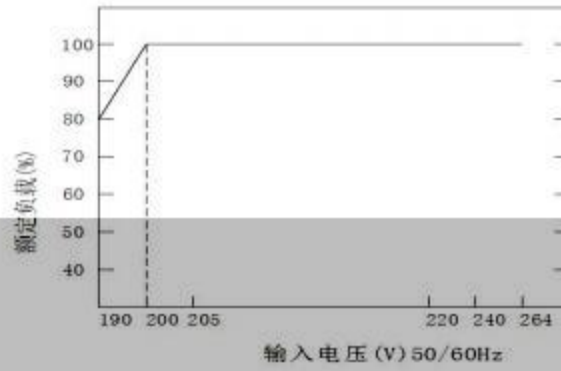

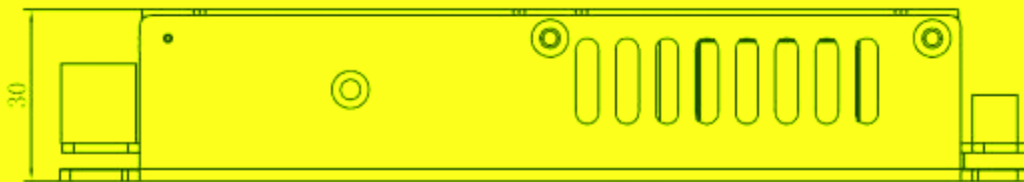
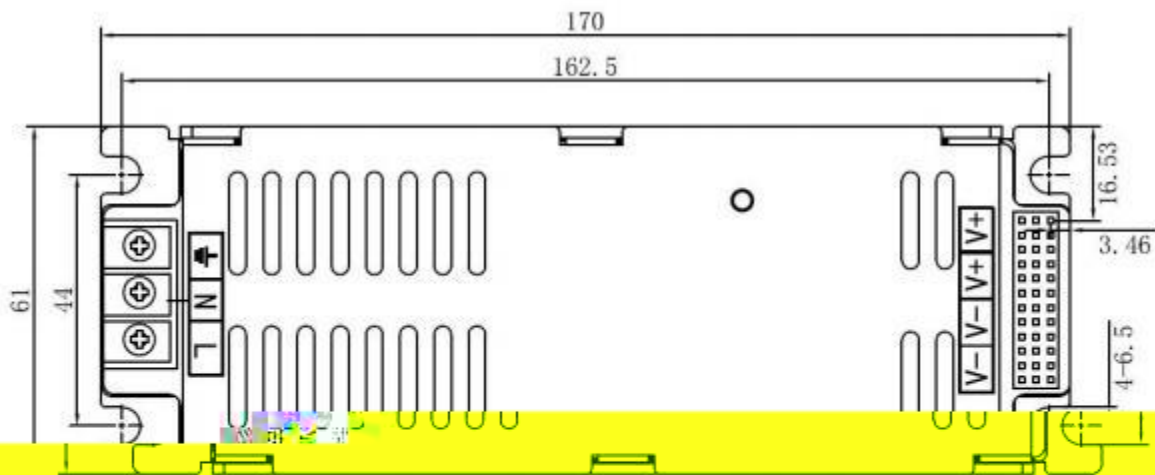
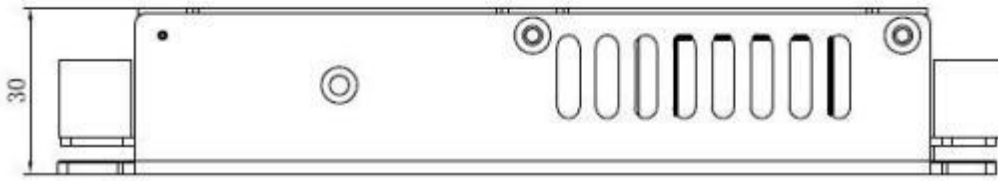
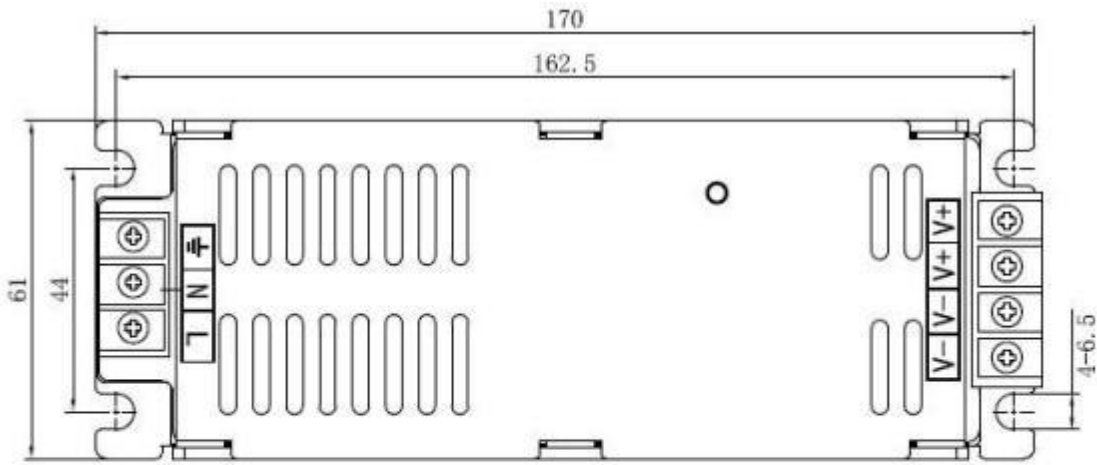

警示

- 使用安装螺丝 M3*6mm.
- 深入外壳螺丝深度 MAX 3mm.
- 详见右图

