

## 产品特性 Product Features



- ✓
- ✓
- ✓
- ✓
- ✓
- ✓
- ✓
- ✓
- ✓

## 应用领域 Application Area

## 产品描述 Product Description



MIL-HDBK-217F Note 2

<input type="checkbox"/>	<input checked="" type="checkbox"/>	<input checked="" type="checkbox"/>	
<input type="checkbox"/>	<input type="checkbox"/>	<input type="checkbox"/>	) <input type="checkbox"/>

# 机构尺寸

Organizational size

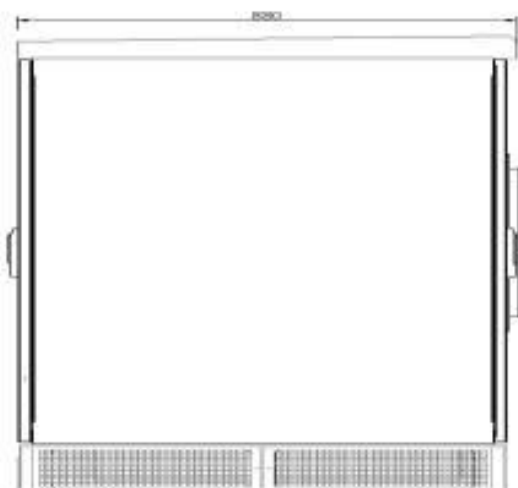
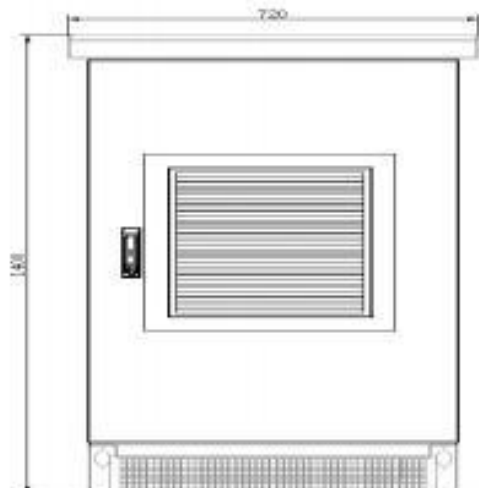
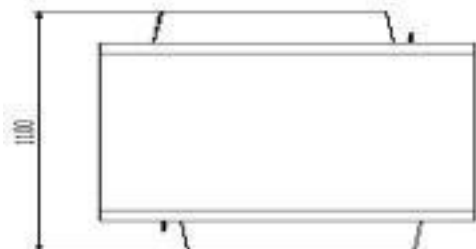
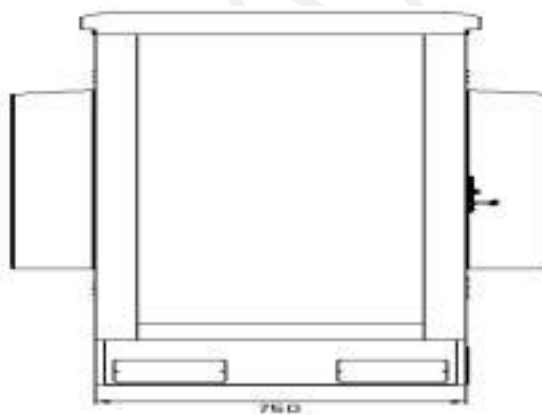
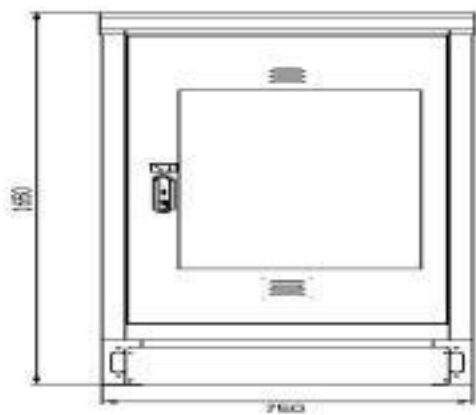

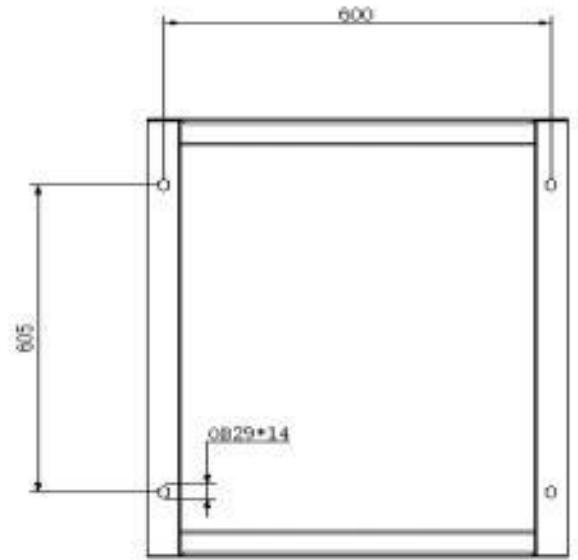
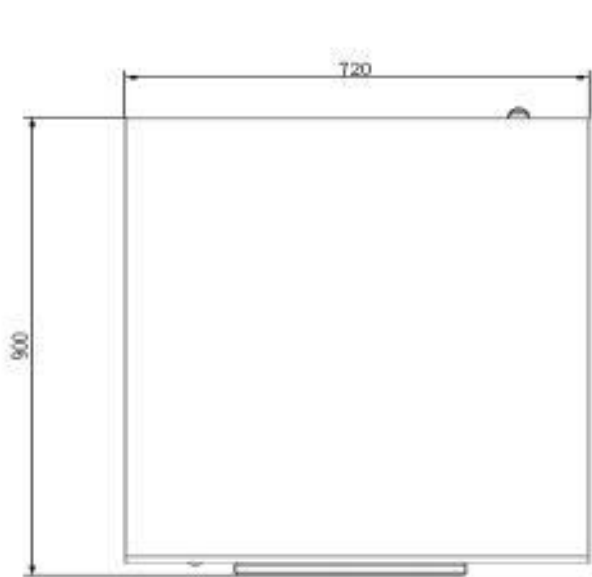

**产品安装 使用说明:**

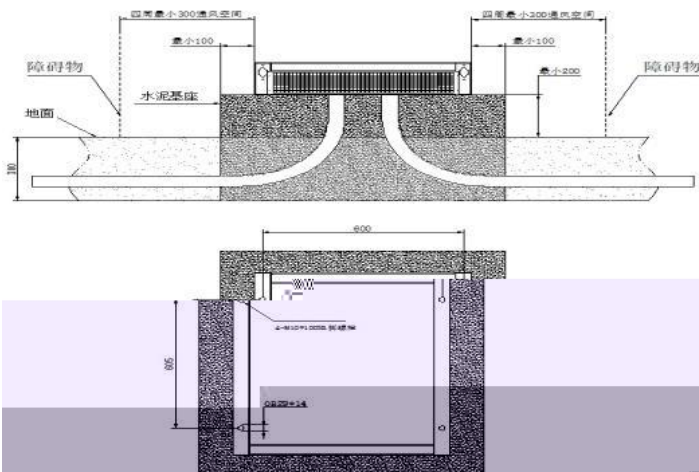
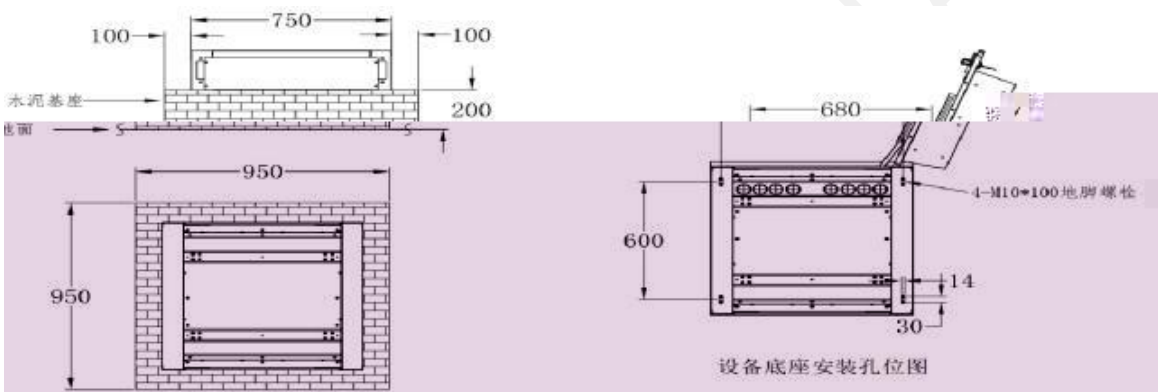

**运输、储存:**  
Transportation and storage: